

OCTAVE

JUBILEE MONO SE

Owner's Manual

English



## FOREWORD

---

I wish to personally thank you for choosing unique OCTAVE products and congratulate you on your purchase of your new

### JUBILEE MONO SE Power Amplifier

Here at our head office in Karlsbad, right on the edge of the Black Forest, we have been designing and building high quality, long-lasting hi-fi equipment for over 20 years that will – quite literally – provide you with hours of musical pleasure for many years to come. Today's loudspeakers and high-resolution source

equipment continue to be very demanding of amplifiers. As a result, achieving improved amplifier sound quality requires greater levels of technical innovation than ever before.

OCTAVE specializes in the ongoing development of upgradeable circuit designs and has earned a reputation over recent years as a world leader in the field of high-end tube amplifier design. Thanks to our years of experience and our in-depth understanding of amplifier technologies and their side effects, OCTAVE is able to achieve a musical quality and degree of reliability that seemed impossible or unaffordable only a few years ago.

I trust that you will enjoy many hours of wonderful music with your OCTAVE amplifier.



Andreas Hofmann  
Chief Designer and CEO of OCTAVE Audio



## CONTENTS

		Page
	Foreword	
1.	Introduction .....	4
1.1	What makes OCTAVE amplifiers special .....	4
1.2	JUBILEE MONO SE product description .....	5
2.	Safety instructions .....	6
2.1	Before you begin .....	6
2.2	Placement.....	7
2.3	Before powering up .....	7
3.	Getting started .....	8
3.1	Unpack and check the content .....	8
3.2	Removing the grille.....	8
3.3	Installing the power tubes .....	9
3.4	Recommended procedure .....	10
4.	Operating components .....	12
4.1	JUBILEE MONO SE rear panel.....	12
4.2	JUBILEE MONO SE top control panel .....	14
5.	Advanced functions .....	16
5.1	Bias measurement facility.....	16
5.1.1	How the bias works .....	17
5.1.2	How to set the bias .....	17
5.2	The electronic protection system.....	18
5.3	Soft Start, inrush current limitation .....	18
5.4	Power Pre Selector.....	18
5.5	Muting function .....	19
5.6	Ecomode.....	19
5.7	Remote operating .....	19
6.	Tubes .....	20
6.1	Tube layout .....	20
6.2	General procedure for changing tubes.....	21
6.3	Tube service life.....	21
6.4	Removing the protective cover to change tubes .....	22
6.4.1	Removing the grille to change output tubes .....	22
6.4.2	Removing the side panel to replace driver tubes .....	22
7.	Troubleshooting .....	23
7.1	In general.....	23
7.2	Identifying defective tubes .....	24
8.	Technical data and dimensions .....	25
9.	Technical data, diagrams .....	26
10.	FAQ .....	28

## 1. INTRODUCTION

---

### **1.1 What makes OCTAVE amplifiers special**

#### **Technology**

Tubes themselves do not themselves guarantee high quality sound. Only by partnering them with innovative electronics designed to create the optimum conditions for the tubes you can achieve consistently high sound quality.

OCTAVE amplifiers are equipped with a power management system whose design is unique. This electronic monitoring and protection system is comprised of a soft-start control and a protection system. An electronic control module regulates and controls all the functions of our amplifiers. When you switch it on, the soft start circuit ensures that the tube heaters and operating voltages are ramped up gently. If a fault should occur, the protection system steps in to switch the power off virtually instantaneously. This intelligent power management system guarantees total protection against all conceivable faults.

An optimized power supply, sophisticated power supply circuitry and the high load stability of the output stages ensure that every power amp and integrated amp bearing the OCTAVE name is capable of developing its full sonic qualities with virtually any loudspeaker.

Together, these measures deliver a supremely consistent sound quality and a dependability that is recognized as world class.

#### **Manufacturing**

Every OCTAVE amplifier is 100 percent "made in Germany". Our products are built individually by hand and thoroughly tested before they leave the factory. We design and make our own custom transformers. We maintain extremely high quality standards through close cooperation with specialist suppliers and by insisting on producing mechanical components in house on the latest CNC machines. The most important contributing factor, however, is the highly qualified and enthusiastic team working here at OCTAVE. The company owner, Andreas Hofmann, retains ultimately responsibility for the design and development of all OCTAVE products.

#### **Sound**

OCTAVE is fully convinced of the musicality and sonic superiority of tubes. But our experience tells us that using tubes does not automatically lead to audiophile sound quality. We appreciate that the sound characteristics of an amplifier are a result of the interaction of its component parts. This means that a high degree of technical skill must be applied to optimizing every detail in order to design a reliable amplifier that will maintain its characteristics over time and that will convince the critical listener over the long term that its reproduction of music is both honest and natural

## 1. INTRODUCTION

---

### 1.2 JUBILEE MONO SE product description

The JUBILEE MONO SE monoblocs are push-pull power amplifiers in pentode configuration. The power amplifiers deliver approx. 400W at 2% THD.

OCTAVE power amplifiers have always set new standards.

Andreas Hofmann's RE 280 stereo power amplifier left traditional power amp technologies far behind when it was first introduced. It goes without saying that this amplifier - like all OCTAVE products since - was equipped with OCTAVE's proprietary Power Management and Protection electronics

#### POWER MANAGEMENT

The *Power Management* system monitors and controls the heating and supply voltages at switch-on. This is tremendously important in extending the service life of the tubes and maintaining a consistent sound. It also relieves the power supply components of the strain of handling huge surge currents at turn-on.

#### PROTECTION SYSTEM

Many manufacturers neglect to include electronic or even passive protection systems in their tube amps, which means that the life - and indeed the operational safety - of these amplifiers are greatly dependent on factors over which the user has no control. OCTAVE fits its power amplifiers with an *electronic protection system* as a matter of course.

#### LOAD STABILITY

The technical breakthroughs that set the original RE 280 apart were its *optimized input gain section and its power supply*. Indeed, it used a totally new power supply design, featuring double star-grounding and supply voltage isolation. The optimization of the input stages provided absolute immunity from influences such as the loudspeaker load, together with excellent phase stability for highly accurate push-pull operation and an extension of the usable frequency range up to 80kHz. From a sound quality point of view, these enhancements delivered a consistent tonal performance and independence from the impedance response and efficiency level of the speakers.

#### PENTODE DESIGN

With the JUBILEE MONO SE power amplifiers, Andreas Hofmann has gone one step further. While they have the same power management and optimized input stage as other OCTAVE power amps, they benefit from an innovative and enhanced output stage configuration. What is revolutionary about this new generation of amplifiers is that we have employed the classic, yet almost forgotten, *pentode configuration*.

The classic pentode configuration was quite commonly used in earlier power amplifiers. It offered the benefits of reliability and a relatively high power output. From a modern perspective, its disadvantage was reduced dynamic stability and a high level of distortion. These effects are not a direct result of the pentode itself, but rather of the circuitry employed at the time.

Andreas Hofmann has now developed a new design that eliminates the drawbacks of the classic pentode configuration. This innovative design involves the use of a second, separate power supply circuit for the auxiliary current needed for the pentode mode of operation. The characteristics of this enhanced pentode circuit are virtually ideal from both a sound quality and an engineering point of view. Among the welcome side effects of the enhanced pentode circuit are absolute immunity against interference and fluctuations in the supply voltage, and an ability to accept compatible output tubes.

#### BIAS

A further effective feature is the *bias measurement facility*.

Unlike the simpler class-A power amplifier type, AB amplifiers require adjustment of the negative grid bias to optimize the idle current for the power tubes. The setting can change as the tubes age and it must also be adjusted whenever tubes are replaced. Normally, this requires test equipment and knowledge of what and where to measure, but with the JUBILEE MONO SE, you can check and adjust the bias any time the amp is on.

This adjustment has a huge influence on the sound quality and performance characteristics of an amplifier (see bias diagram under Technical data).

## 2. SAFETY INSTRUCTIONS

### 2.1. Before you begin

Please read this Owner's Manual before you use the equipment for the first time.

*Operating the amplifier without its protective grille is dangerous and not recommended.*

**In case of emergency: disconnect the plug from the mains supply.**

Never use an amplifier that is damaged or faulty. Make sure that it cannot be used until it has been repaired by a qualified service engineer.

Make sure that there is easy access to the IEC socket and power cord.

**Do not open the case**

There are dangerously high voltages and hot tubes inside this equipment. To avoid burns or the risk of electric shock, never allow anyone except qualified personnel to open the case or remove the grille.

**Servicing and maintenance**

For reasons of safety, please ensure that servicing, repairs and other modifications to OCTAVE equipment are carried out only by a qualified technician. Fuses should be also be changed only by a qualified technician. Always replace fuses with ones of the same type and rating. If your amplifier requires servicing, please ship or take your equipment directly to OCTAVE or to one of our authorized service centers.

**Explanation of the warning symbols:**



The lightning flash with arrowhead symbol within an equilateral triangle is intended to alert the user to the presence of uninsulated 'dangerous voltages' within the product's enclosure that may be sufficient to constitute a risk of electric shock to persons.



The exclamation point within an equilateral triangle is intended to alert the user to important operating and maintenance instructions.



**Before connecting up**

Make sure that the voltage of your amplifier matches with your electricity supply voltage.

**Grounding**

This amplifier is a protection class 1 device (with an earth conductor). To exclude the risk of electric shock in the event of a fault, the unit must be grounded. Use a three-core mains cable with a three-pin plug (supplied).

**Safety warning: Hot tubes!**

Warning: Remove the protective grille at your own risk. OCTAVE cannot accept any responsibility for injuries caused by the removal of this grille.

**Warranty**

OCTAVE can only guarantee the safety, reliability and performance of this unit if modifications and repairs are carried out by specialized personnel and if the amplifier is operated in accordance with the instructions contained in this manual.



## 2. SAFETY INSTRUCTIONS

### 2.2. Placement

#### 1. Location

OCTAVE equipment is designed strictly for use in a dry domestic environment. Do not use it in the open air or in damp environments!

Never place plants or liquid filled containers on your OCTAVE equipment. Take care that objects do not fall or liquids are not spilled into the enclosure. Should this happen, remove the mains plug immediately and have your amplifier checked by a qualified service technician.

Condensation may form if the amplifier is taken from a cold environment into a warm one. If you do this, wait until the amplifier has reached room temperature and is dry before switching it on.

Avoid installing the unit close to sources of heat such as radiators or anywhere that it may be in direct sunlight.

Do not operate the unit near flammable materials, gases or vapors. Avoid areas where there may be heavy accumulations of dust or where the unit may be subject to mechanical vibration.

Place your OCTAVE amplifier on a stable, even surface.

#### 2. Grille

Never operate the amplifier without the protective grille.

#### 3. Ventilation

Make sure that your amplifier has a good flow of air around it. If you intend to install your equipment in a cupboard or a shelf unit, ensure that there is at least a twenty-centimeter gap between the ventilation slots and the walls all around the amplifier. The rear panel of cupboards should have ventilation holes to prevent heat buildup. Do not place the equipment on a soft surface such as carpet or foam sheeting.

### 2.3. Before powering up

1. In your own interest, please observe the Safety precautions and positioning advice (Chapter 2)
2. Before connecting your OCTAVE amplifier up, switch off all the other equipment that you intend to connect to it. This will avoid a source of possible problems when you plug these components in.
3. Connect the outputs from your preamplifier to the appropriate inputs on the JUBILEE MONO SE.
4. Connect your loudspeakers to your JUBILEE MONO SE amplifiers, making sure that you observe the correct polarity (positive on the amplifier to positive on the speakers).
5. Check that the amplifier is switched off before connecting the power cable to the wall socket.
6. The mains power switch for the JUBILEE MONO SE is located on the rear panel (see Chapter 4.1 - Operation).  
Note according to the CE standard: To fully disconnect or isolate the amplifier from the mains, you must unplug the power cable from the amplifier. Turning the unit off with the power switch of the device ensures no safe isolation from mains power.



## 3. GETTING STARTED

### 3.1. Unpack and check the contents

**Package contents for two JUBILEE MONO SE:**

1. 16 power tubes and 4 spare tubes packed separate
2. Tools: 3 screwdrivers:
  - ◆ 4.0 x 100 slot screwdriver for adjusting the bias
  - ◆ TX 10 torx screwdriver for removing the side panels
  - ◆ 2.5 x 60 Allen key for removing the cover
3. Octave cleaning Cloth and Soft Gloves
4. Owner's manual with declaration of quality

### 3.2. Removing the grille

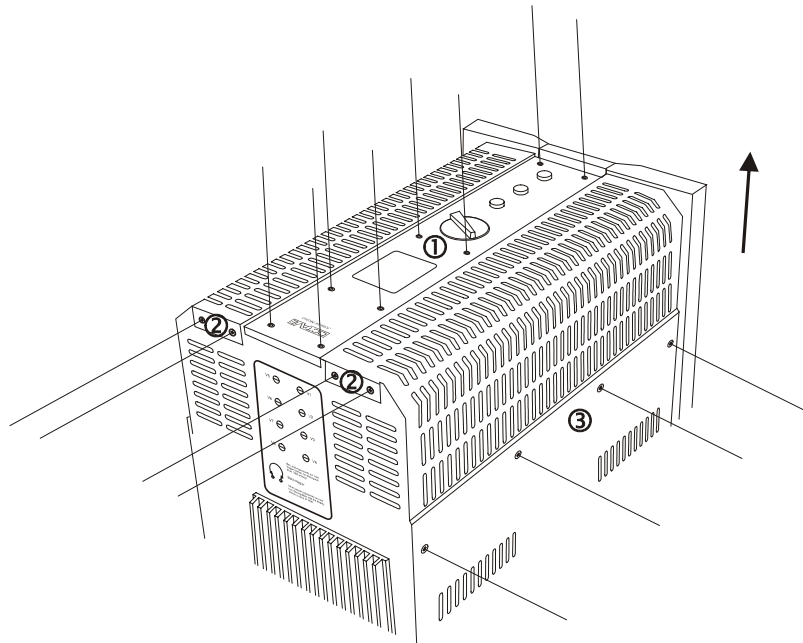

1. Please don't connect the amp to the mains before the tubes are installed because of your own safety.
2. Undo the eight socket head screws on the top cover panels ① (4 screws on each cover; tool: Allen key).
3. Undo the 2 x 2 socket head screws ② on the rear panel (tool: Allen key)
4. Release the 2 x 4 torx screws on the side panel ③ (tool: torx screwdriver)
5. Remove the protective grilles

### 3. GETTING STARTED

#### 3.3. Installing the power tubes

Jubilee Mono SE service carton:

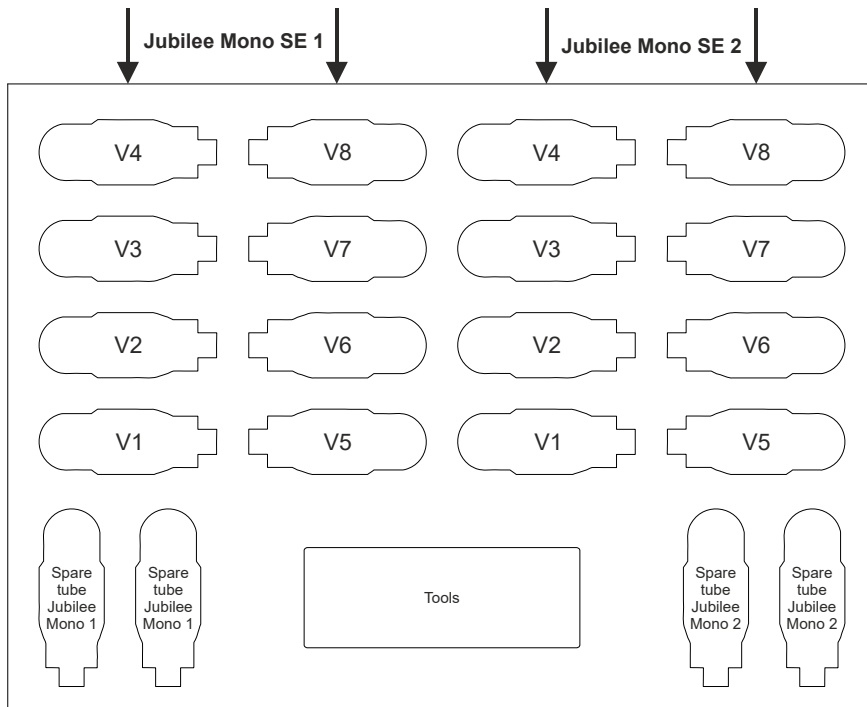

The output tubes are numbered with the position (1 - 8 ) and the serial number of the corresponding unit

**Please don't mix up the tubes from JUBILEE MONO SE 1 to JUBILEE MONO SE 2!**

Insert the power tubes into their sockets. Ensure that you correctly locate the anti-rotation lug on each of the tubes.

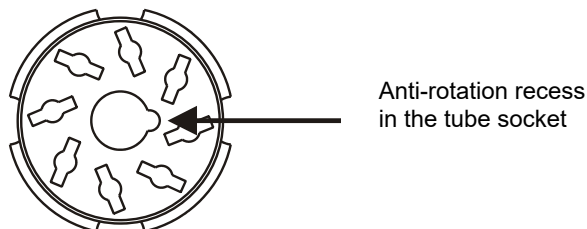

### 3. GETTING STARTED

#### 3.4. Recommended procedure



**Please note:** Before you use your amplifier for the first time, we **strongly recommend** you to follow the procedure described in the following eight points, even if your dealer has already set the amplifier up for you. By checking these eight points, you will also familiarize yourself with the controls of your amplifier. Furthermore it will eliminate the possibility of user's error.

1. Connect the power amplifiers to an earthed wall socket using the power cable supplied.
2. Connect your loudspeakers ④ and preamplifier to the rear panel of the JUBILEE MONO SE amplifiers. (see chap.4.1)
3. Push the power switch ③ above the power inlet socket on the rear panel. (see chap. 4.1)

#### Start phase

4. Now push the power (stand by) button ⑩ on the top of the amplifier. The unit will be switched on electronically via an internal relay and you will hear a clicking sound as the relay switches in. LED A and LED B light up in the display and - depending on the position of the Power Pre Selector - LED C or LED D. The display meter reads 000. (see chap.4.2 ⑭)  
The start phase takes approx. 4 - 5 minutes. LED A (start LED) remains lit during this time. Since the amplifier is muted by default, LED B (muting LED) illuminates regardless of the position of the muting switch. Pressing the muting button makes LED B slightly brighter.  
It is not possible to play music during the start phase. The Power Pre Selector switch should set to "low"; the green LED C illuminates this function.
5. After about two minutes, you will hear the sound of a second relay cutting in. This indicates that the output tubes are being heated up and they will begin to glow.

6. LED A and B go out once the start phase has been completed. Your amplifier is now ready for use. (You must deactivate the muting function, in case this function is ON, so that LED B is extinguished.)

#### Functional test: Power Pre Selector

7. Set the Power Pre selector to bias "Low", indicated by LED C of the display.
8. Before listening to music, check the amplifier for correct operation and make adjustments if required.

Check the operation of the tubes and the amplifier itself using the bias measurement selector switch ⑬.

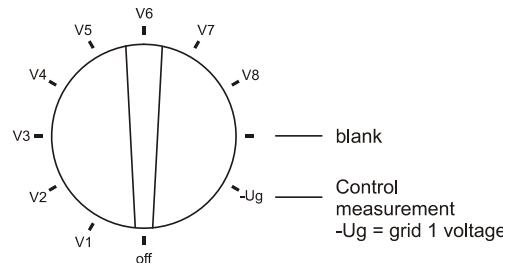

Switch in position V1:

The bias current of output tube V 1 is selected with the switch in position V 1, and the reading is shown in the meter

**Bias low reading: approx. 250-400**

Turn the knob to check all eight tubes. All eight tubes will give a similar reading. If the reading of the tubes is too high use the screwdriver supplied to turn the bias control regulators ⑨ on the rear panel. Turn the bias regulators until you get a reading of approximately 400, +/-20%.

**If one (or more) of the eight tubes shows a reading of 0 or well above 400, the tube(s) must be replaced.**

### 3. GETTING STARTED

---

#### **Functional test Power Pre Selector in position "Bias high"**

After checking the readings in the low setting, you can activate "Bias high". ⑫  
Bias high is indicated by the blue LED D. The reading of the display is increasing slowly to a value of 800 - 1000. Check the reading of each of the eight tubes by selecting them one by one. Deviations from 950 - 1050 are acceptable. If a reading settles at substantially higher than 1000; you have to adjust this tube with its corresponding bias regulator ⑨.



**Bias high reading: 1000**

***This is now the default setting of the bias control, which should be maintained.***

#### **Functional test, muting**

If all values are correct, you can check the "Muting" function. When the muting function is active, not only the inputs are short-circuited to allow signal cables to be connected; the current to the power tubes is also reduced to nearly 0.

Checking the bias of the tubes while the muting function is ON, the reading of the display shows the value less than 100 of all tubes. The meter reading will gradually increase when you switch the muting function off. This soft start-up prevents pops and regulation noises being sent to your speakers.

When the muting function is active, the green LED B illuminates in the display and the LED next to the rear panel input selector switch goes out to indicate that the amplifier has been muted. (⑦, rear panel)

#### **End of activation phase**

8. When you have confirmed that the amplifier is operating correctly and have made any necessary adjustments, you can go ahead and use the amplifier. However, the amplifier will not pass a signal to the loudspeakers if the red LED E illuminates during the start phase or while listening to music. This LED lights up to warn you that the electronic protection circuit has switched off the amplifier. (see chap. 5.2)

## 4. OPERATING COMPONENTS

### 4.1. JUBILEE MONO SE rear panel

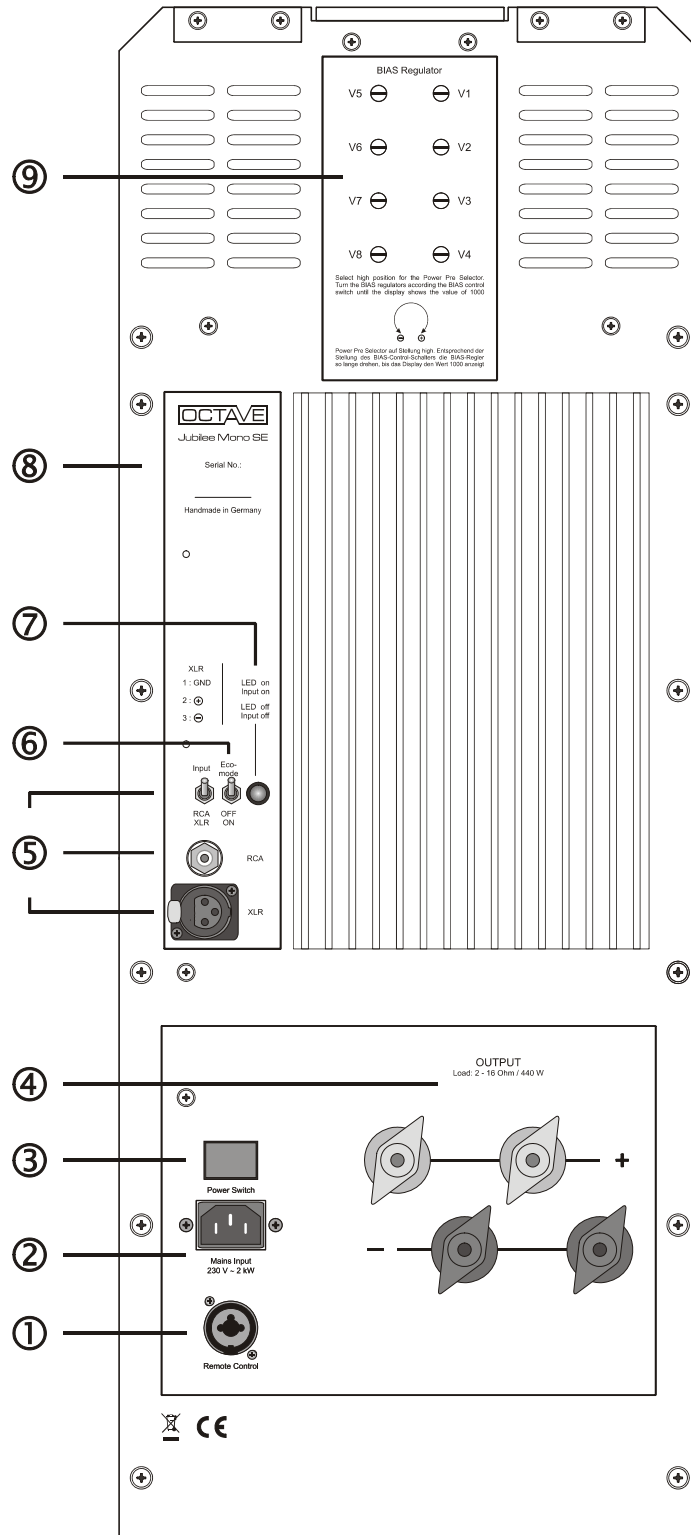

## 4. OPERATING COMPONENTS

### 4.1. JUBILEE MONO SE rear panel

① **Remote operation**

DC-Input for remote operation.  
Connector: 6,3 mm Mono-Plug  
Voltage: 12 V / 50 mA  
(see chap. 5.7)

② **Mains Input**

AC input, IEC socket

③ **Mains power switch**

Please make sure that the power switch and the mains input are always accessible.

④ **Loudspeaker outputs**

Loudspeaker terminals. Both, plus- and minus-terminals are connected together to allow bi-wiring of your system.

⑤ **Input section**

The amplifier is equipped with an RCA and an XLR input. You can select the appropriate input using the input toggle switch. You can connect both inputs at the same time and switch between them.

XLR pin connections:  
1 = ground, 2 = +, 3 = -

⑥ **Ecomode Switch**

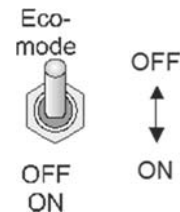

Ecomode off: Ecomode automatic is off.  
Ecomode on: Ecomode automatic is on.  
(see chap. 5.6)

⑦ **Muting LED**

- lights up when the input is active  
- goes out when the Muting function is activated. (see chap. 5.5)

⑧ **Model identification plate**

Model and serial number

⑨ **BIAS regulators**

(see chap. 5.1)

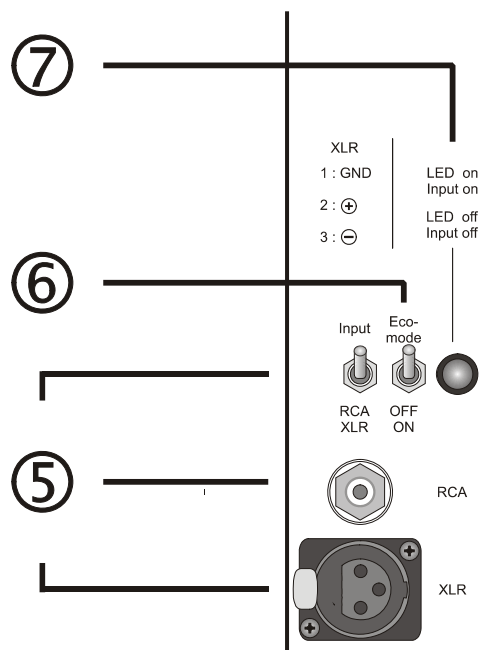

## 4. OPERATING COMPONENTS

### 4.2. JUBILEE MONO SE top control panel

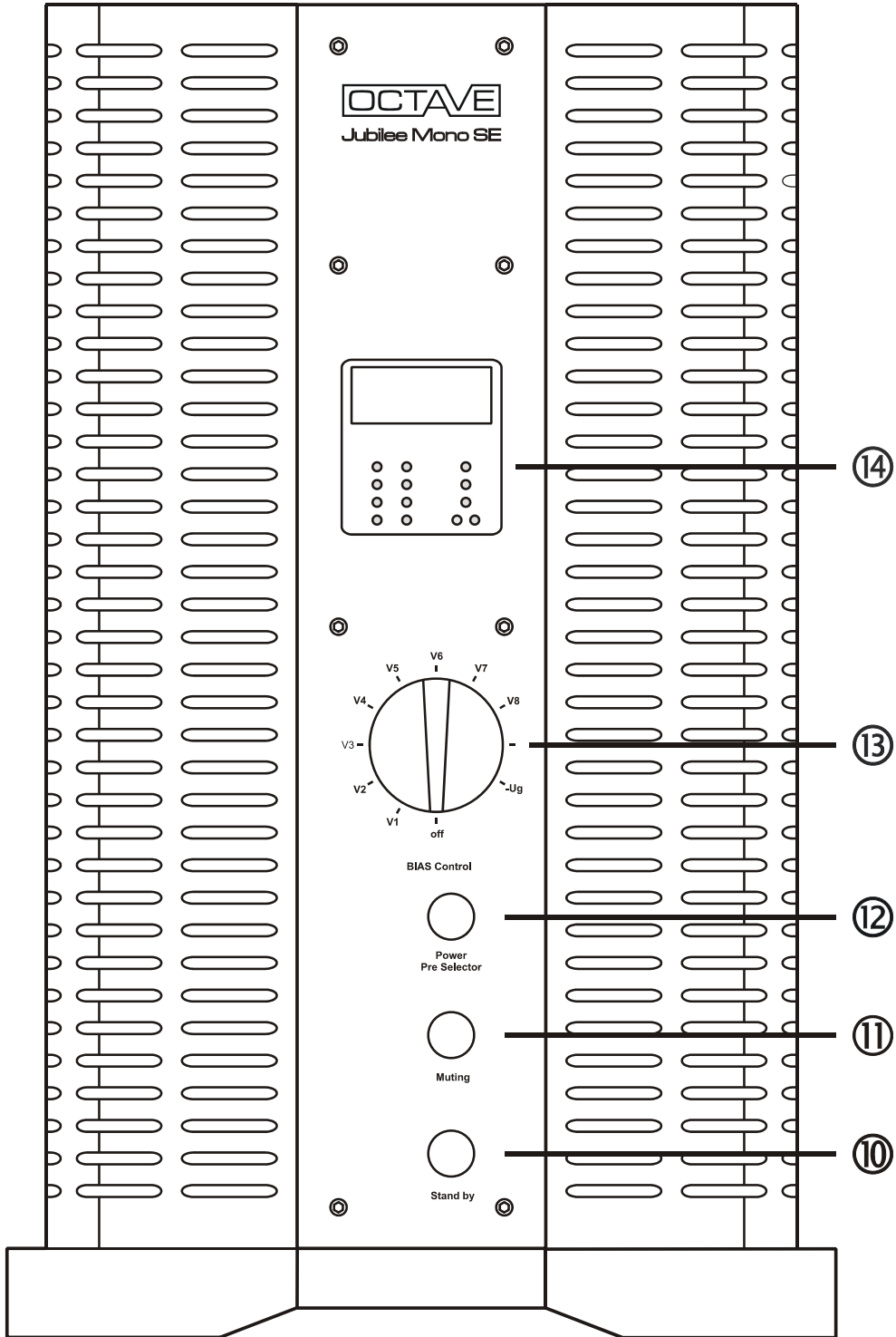



## 4. OPERATING COMPONENTS

### 4.2. JUBILEE MONO SE top control panel

**⑩ On/Standby (Power) button**

The push button switch in the top control panel can only be used to switch the amplifier on when the mains power switch **③** has been turned on at the rear of the unit.

000 will appear in the display **⑭** to indicate that the unit is On.

During the turn-on phase, the yellow A (indicating the start phase) and green B (indicating that the unit is muted during the start phase) LEDs light up in the display (see chap. 5.3).

**⑪ Muting button**

This function disables the inputs of the power amplifier. The green LED B lights up in the display and the LED next to the input selector switch **⑦** goes out. (see chap. 5.5)

**⑫ Power Pre Selector**

This function reduces the bias current to approx 50% of its nominal value. The low bias setting is useful when the power amplifier is to be used at low volume or as a specific reference setting during the activation phase for checking the correct operation of the unit and for checking the tube parameters (see chap. 5.4).

Overall power consumption is also reduced in this setting, which produces less heat.

The green LED C on the display indicates the low bias setting; the blue LED D indicates the high bias setting.

**⑬ Bias measurement selector switch**

This selector switch simplifies checking and adjusting the idle current of the eight output tubes. The readings are displayed in the digital meter. (see chap. 5.1)

**⑭ Display**

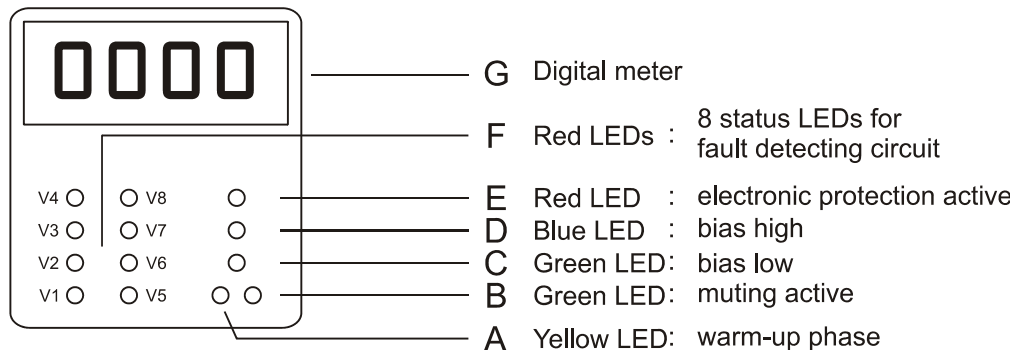

## 5. ADVANCED FUNCTIONS

### 5.1 Bias measurement facility

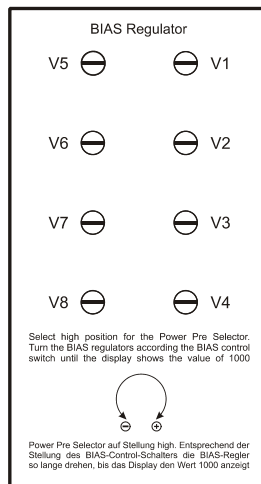
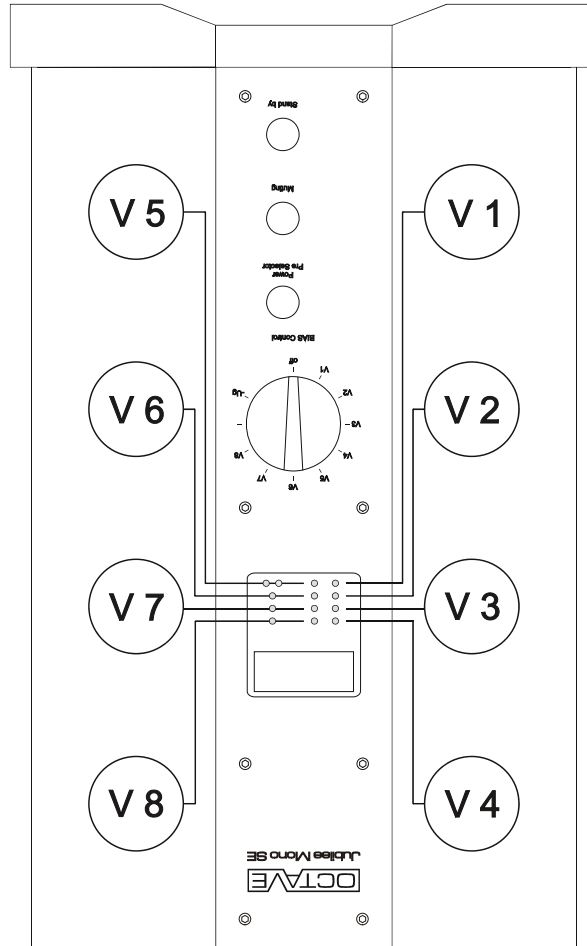

## 5. ADVANCED FUNCTIONS

---

### 5.1 Bias measurement facility

#### 5.1.1. How the bias works

The bias measurement facility makes it easy for you to check and adjust the idle current of the output tubes. Getting the bias setting right for all eight tubes is relevant to both for the sound of the power amplifier and for the service life of the tubes. This is why we have incorporated a bias measurement facility into the JUBILEE MONO SE blocs that allows you to set the bias yourself without the need for test equipment.

The protective screen does not have to be removed to do this.

The driver tubes inside the unit require no adjustment.

**Changes caused by aging of the tubes can be compensated for. The sound of the amplifier remains constant throughout the service life of the tubes.**

#### 5.1.2. How to set the bias

Make sure that no signal is playing through the amplifier when you are adjusting the bias. The preamplifier should be switched off, although you do not need to disconnect the loudspeakers.

#### *Special cases: Faulty tubes*

#### **Procedure**

1. The amplifier must be operated for at least 15 minutes to allow the tubes to reach their operating temperature. The adjustment is made in the bias high setting (blue LED in the display).
  2. Turn the bias measurement selector switch  to position V 1. The meter in the display should read 950 - 1050. In case of misadjustment you have to adjust the value. The corresponding bias-regulators for the output tubes are located on the rear panel. Turn regulator 1 clockwise in case the reading of tube 1 is less than 1000 and counterclockwise in case the reading is higher than 1000. Check the bias of the other tubes, V2 ...V8, and adjust their bias via the corresponding regulators.
  3. After adjusting all tubes you should check V 1 up to V 8 again. A small re-adjustment may be necessary to reach the final matching reading of all eight tubes. The reading of all tubes should be equal within the tolerance range from **950 to 1050**.
4. You should remove any tube that fails to provide a stable reading after an initial warm up period.
  5. Any tube that reads 0 is defective and non-functional and must be replaced. Tubes showing a reading of 0 cannot be corrected by turning up the bias control.
  6. If you notice a constantly rising reading on a tube, accompanied by the red protection LED E turning on at some point, this means that the power amplifier has switched itself off electronically. The readings for tubes V 1 - V 8 fall to 0. No adjustment is possible if the electronic protection is triggered.  
(See chap. 5.2 "Electronic protection")

## 5. ADVANCED FUNCTIONS

### 5.2. Electronic Protection System

The JUBILEE MONO SE features a comprehensive electronic monitoring and protection system. This system will automatically switch off the JUBILEE MONO SE in case of a fault occurring in the power section.

The protection system has been designed to keep the unit safe from the consequences of overloads of any kind and to protect the output tubes from current surges.

The RED "Protection" LED E lights up to indicate that the protection system has tripped. Depending on the fault one or more of the eight LEDs in section F (see chap. 4.2) of the display light up additional with the protection LED E. The LEDs in F indicate the tube that was causing the protection to trigger. In cases of excessive listening levels causing high overload one or more of the LEDs in F may light up although the tubes are ok.



The amplifier will not play music once the protection system has tripped and you will not be able to check or adjust the bias setting.

The digital meter will show "000" for each of the eight output tubes once the protection was triggered.

### 5.3. Soft-Start, inrush current limitation

The amplifiers input and output tube heaters as well as its high-voltage rails are logic controlled to ensure that the conduction of the output tubes as well as input stage voltages are constantly monitored and controlled by the **Power Management System** to protect the vital internal parts (tubes, rectifier, electrolytic caps, switches, etc.) against excessive turn-on current.

### 5.4. Power Pre Selector

The Power Pre Selector allows to set the bias (quiescent current of the tubes) in two settings. "High", indicated by the blue LED D and "Low", indicated by the green LED C.

In position "High" the output power is set to maximum and in position "Low" the output power and the sound quality is limited. The power consumption of the JUBILEE MONO SE amplifier is reduced in the position "Low". "Low" is the recommended setting to break in new

The following conditions can cause the protection system to trip:

- Overdriving the amplifier to excessive levels or with excessive levels of low frequency.
- A speaker cable short circuit while the speakers are being driven at high listening levels.
- A fault in one or more of the output tubes.
- A fault in one of the preamp tubes. This is a very rare situation

Once the protection system has been tripped, it will remain active. You can only deactivate it by switching the amplifier off and on again - assuming, of course, that you have fixed the problem. Allow the unit two minutes to cool down before switching it back on. If possible, identify and eliminate the cause of the problem (see chapter 7 "Troubleshooting").

If it is not clear what has caused the protection system to trip, we recommend that you check the bias before attempting to use the amplifier again. Tube faults can result in widely drifting bias settings. When these settings exceed a particular value they can cause the protection system to trip.



During the Soft-Start-phase, adjusting the bias and listening music is not possible.

output tubes and for the case the amplifiers have to deliver low output levels while listening news or something similar.

During the position "Low" the reading of the display while checking the bias of the eight tubes is showing a value of 400 +/- 20 %. The deviation of the reading in position "Low" is normal and there is no need to adjust the tubes.

## 5. ADVANCED FUNCTIONS

### 5.5. Muting function

LED B indicates the Muting function in the display. The Muting function is a helpful feature that allows you to connect or disconnect signal cables to the JUBILEE MONO SE power amplifiers without switching off the unit.

While "Muting" is active the bias of the tubes is regulated to 0. Therefore it takes a few seconds until the amplifier is playing again after switching off the Muting. Once the input is released the LED near the input jacks lights up.

### 5.6. Ecomode (power saving mode)

The **Ecomode** serves to reduce heat and unnecessary power consumption when the unit is switched on but not in use. After 10 minutes without receiving signal the Ecomode is turning down the power of the Tube Output stage. In this "sleep" mode, the JUBILEE MONO SE draws less than 100 W Idle current compared to approx 300 W in normal operation mode. Therefore the running unit produces no heat, because the heater voltage and the high voltage of the power amplifier section are switched off. When the music signal is sensed once again by the Ecomode electronic, the Ecomode circuit will turn the unit back on, with a warm-up/start-up delay of approximately 60 seconds until the unit will be operational.

The Ecomode also serves to increase the lifetime of the tubes, while having an added benefit of **improved safety** allowing the JUBILEE MONO SE owner a level of security against any problems when leaving the unit powered on. The Ecomode is a safety and energy-saving feature that is unique in our amplifier range.

**Eco off:** The Ecomode electronic is off. The JUBILEE MONO SE is permanent in operation.

**Eco on:** The Ecomode electronic is activated. After a period of 10 min without receiving a signal from the preamp the Ecomode electronic is turning the JUBILEE MONO SE down. This is indicated through the LEDs A + B

Note:

If you switch on the JUBILEE MONO SE with Ecomode active, it will go through the start procedure. If it fails to detect a music signal, it will shut down after 10 minutes. Ecomode is not the same as standby, however, because certain sections of the amplifier remain on.

**Important!**

You cannot adjust the bias in Ecomode once the amplifier has powered down!

The signal switching level of 0.5mV results in approx. 40µW output power of the JUBILEE MONO SE. In case of a speaker with a high efficiency an adjusted listening level can be lower than this value. The Ecomode would drive the unit down. In such cases the Ecomode should be switched off

### 5.7 Remote operation

The remote control input allows remote operation of the JUBILEE MONO SE amplifiers driven by a control voltage of a preamplifier. The remote control input is a 6.3mm mono plug ①. Such a cable is available from us or the PA accessories market. Normally used for microphones.

The remote input is not connected to any other voltage inside the JUBILEE MONO SE power amplifier. Control voltage and current for the JUBILEE MONO SE is 12V, 50mA.

The Jubilee preamp is equipped with two remote switch output jacks on the rear front of the power supply of the preamp.

## 6. TUBES

### 6.1. Tube layout

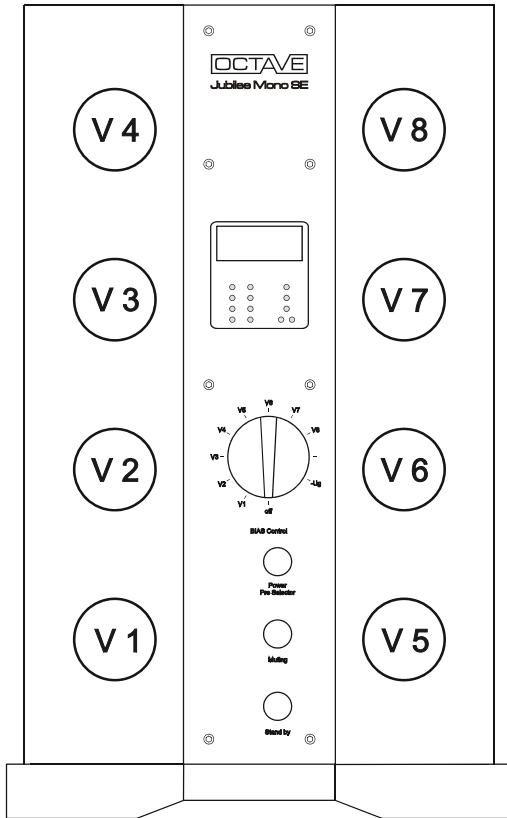

Output tubes:

**V1 - V8: KT120**

The output tubes should be selected, but due to the separate bias regulators the selection grade is not critical

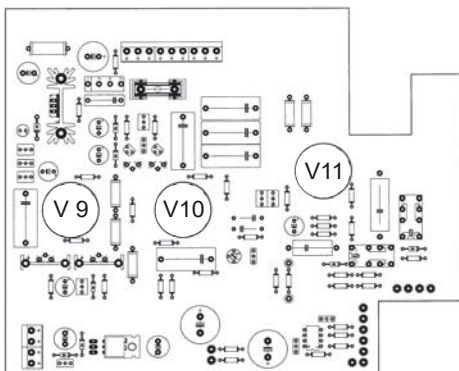

Driver tubes:

**V9 - V11: ECC82  
=12 AU 7**

V 9: Output stage driver  
V10: Main amplifier tube  
V11: Input tube

The board is located on the rear panel inside the amplifier. (see chap. 6.4.2)

## 6. TUBES

### 6.2. General procedure for changing tubes

Only qualified personnel should replace tubes.

**General procedure:**

Switch the amplifier off and disconnect the plug from the mains supply. Allow it to cool down for 10 minutes.

1. Remove the protective grille.  
(see chap. 6.4.1)
2. Remove the old tubes by carefully pulling out them upwards.
3. Fit the new ones.  
Insert the power tubes into their sockets as shown on the tube layout. Ensure that you correctly locate the anti-rotation lug on each of the tubes.

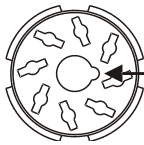

Anti-rotation recess on the tube socket

**Adjustment after the tube changing**

New driver tubes

Replacement driver tubes require no adjustment.

New output tubes:



1. When you have successfully replaced the necessary tubes, replace the grille and panels.
2. **Before you switch the amplifier back on after fitting new output tubes, turn the bias adjustment control regulators counter-clockwise toward minus as far as it will go.** The control is a ten-turn potentiometer, i.e. it takes ten revolutions to go from the maximum to the minimum setting.
3. Switch the amplifier on, carry out the checks described in chap. 3, and adjust the bias as required.
4. Your amplifier is now ready for use. Depending on the type, age and manufacturer of the tubes, you may need to readjust the settings in the first few weeks.

### 6.3. Tube service life

- Thanks to the protection circuits and soft start electronics, the output tubes used in your amplifier should achieve an average service life of 3 to 5 years. We cannot, however, guarantee the service life of the tubes. These are average values, which will vary with the type and manufacturer of the tubes.

The internal protection and soft start circuits cannot prevent tube faults. They are designed to minimize the stress on the amplifier and to protect it should a fault develop. You can select tubes by measuring their characteristics but this does not guarantee that they will last for a long time. Indeed, it is impossible to predict

how long the output tubes will last.

A well-made tube has a life expectancy of between 3 and 5 years. However, it remains impossible to detect certain weaknesses in the structure of a fully functional tube. The protection circuits in the power amplifier will also protect the unit against the damage that a defective output tube could cause.

- Driver tubes can last for 10 years or longer.
- Because tubes have different service lives, you will never have to renew the entire tube complement at the same time.
- Please note that some tubes need a long time (up to 300 hours) to achieve their optimum sound quality.

## 6. TUBES

### 6.4. Removing the protective cover to change tubes

#### 6.4.1. Removing the protective top cover to change output tubes

See chap. 3.2.

#### 6.4.2. Removing the side panel to replace the driver tubes.

Driver tubes normally do not require periodical replacement.



*Operating the amplifier without the side panel is dangerous and not recommended! Tubes should only be replaced by qualified personnel. There are a number of points inside the amplifier that can cause a fatal electric shock if touched.*

1. Switch off the amplifier and disconnect the power cord. Wait 20 minutes until the amplifier and the tubes have cooled down.
2. Remove the right side panel (viewed from the front).
3. To prevent the side panel from slipping and damaging the screws, support the panel at both front and rear using two paperback books.
4. Use the torx screwdriver supplied to remove the 13 Torx screws from the side panel. Work from the top down and remove screw **S** last.
5. Remove the side panel.
6. Replace the tubes as required in accordance with the tube layout. V11 is the tube closest to the right side panel.

Step 1

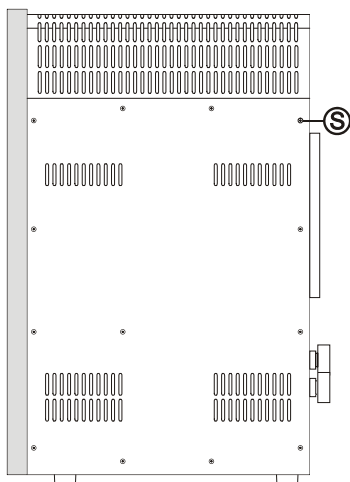

Step 2

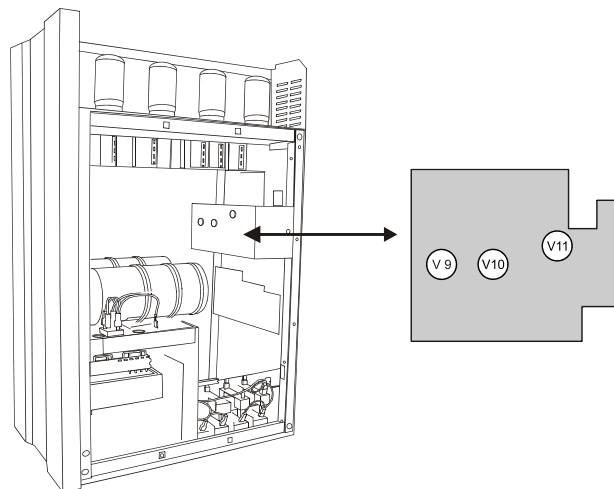



## 7. TROUBLESHOOTING

---

### 7.1 In general

#### ■ Noise and hum

Hum in an audio system is often caused by several system components being grounded separately. It is particularly common in systems containing tuners, VCRs or satellite receivers connected to an aerial, where a hum loop may be introduced via the aerial input.

Although the JUBILEE MONO SE is also grounded, it is equipped with a special technology that reliably prevents ground loops. Should an earth loop nevertheless develop via a tuner or television aerial, we strongly recommend that you use a signal-isolating filter on the aerial connection. This will eliminate all ground loops.

#### **Hum when connecting the power amplifier via XLR:**

When connecting the power amplifier to a preamplifier using XLR cables, make sure that all three pins are connected at both ends.

#### ■ Switching interference

Older fridges and 12 V halogen lamps can cause cracking through the loudspeakers when they switch on and off.

Solution: the only solution is to run your system from a single distribution board - if possible, one that incorporates a mains filter. Under certain circumstances, fitting an inexpensive industrial filter in the power line of your refrigerator may be a more effective solution.

#### ■ The channels are unbalanced and/or there is distortion at certain frequencies

The problem of channel imbalance or distortion in one channel is unlikely to be caused by defective tubes. The most frequent causes are cables and faulty recording devices connected to the record output of a preamplifier.

Solution: Unplug all non-essential components/cables from your preamp. Swap channels to check your speaker and interconnect cables. You will generally be able to locate the fault if it changes channel or disappears altogether.

## 7. TROUBLESHOOTING

### 7.2 Identifying defective tubes

There are especially four reasons why tubes can become defective.

#### 1. Breakage of the heater filament and internal contact problems

The tube's operating current normally drops to 0 when this fault occurs. Because of this, the electronic protection does not cut in. You can confirm this type of fault using the bias measurement facility while the amplifier is on. The problem tube will give a very low reading, or a reading of 0. Use the rotary selector switch to determine the location of the faulty tube. Then replace it (see chap. 6.2 Replacing tubes).

#### 2. Leaking glass envelope

To function properly, the inside of a tube must be a vacuum. Tiny hair cracks or defects in the glass envelope can allow small amounts of air to enter the tube. Initially, the effect is not noticeable. However, the bias measurement system allows you to trace such tubes because they produce a strongly fluctuating reading. Larger amounts of air penetrating the tube cause the shiny silver surfaces in the glass envelope to turn white. The readings for these tubes will be around 0. Once air has entered the tube, the heater filament will burn out. This type of tube failure will not result in damage to other parts of the amplifier. You should replace any tubes suffering from this problem (see chap. 6.2 Replacing tubes).

#### 3. Signs of tube aging

It will normally be necessary to re-bias output tubes at some time during their service life to bring the idle current back to the prescribed setting. Depending on the age, quality, type of construction and the materials used inside the tube, the bias setting may be quite different after a number of years from that of a brand new tube.

To monitor this effect, we have included a Control measurement setting in the bias measurement system

The meter shows the setting required to achieve the correct idle current. With 'bias high' and new tubes, the value is around -400 (for engineers:  $-U_{g1} = -40\text{ V}$ ). The amount of adjustment needed depends greatly on the manufacturing techniques used by the tube manufacturer. You can safely use the tubes in your amplifier until there is insufficient adjustment remaining to set the bias correctly. The specified limits for adjustment are between -200 and -800 on the display.

#### 4. Uncontrolled rise in tube idle current

Mechanical faults, particularly loose connections, can lead to an increase in tube idle current. This increase can be very rapid and is sometimes accompanied by sparking inside the tubes. When such a fault occurs, the amplifier's electronic protection reacts within  $< 0.2$  seconds. The amplifier will switch itself off, making it impossible for the user to locate the tube that has caused the problem.

For this reason, we have incorporated a fault detecting circuit in the amplifier. This subsystem monitors the output tubes alongside the electronic protection system. However, the fault detecting circuitry will recognize which tube is responsible for triggering the protection system and display this information via the 8 Status LED's F in the display. Each LED is allocated to a single output tube. The LED for the faulty tube will remain lit even after the electronic protection has switched the amplifier off. You should replace this problem tube (see chap. 6.2 Replacing tubes).

## 8. TECHNICAL DATA AND DIMENSIONS

### In- and Outputs

Inputs	1 x RCA, 1 x XLR
Outputs	2 x Loudspeaker output

### Amplifier

Power output	400W RMS and 450W peak power into 4 ohms
Frequency response	10Hz - 80kHz / $\pm 0.5$ dB
Total harmonic distortion	< 0.1% at 10W into 4 ohms
Signal-to-noise ratio	> 103 dB
Minimum load impedance	2 ohms
Gain/input sensitivity	+ 28dB / 1.5V

### General

Power consumption	420W minimum, 800W at full power
Weight:	64 kg per monobloc
Dimensions	Overall dimensions in mm:

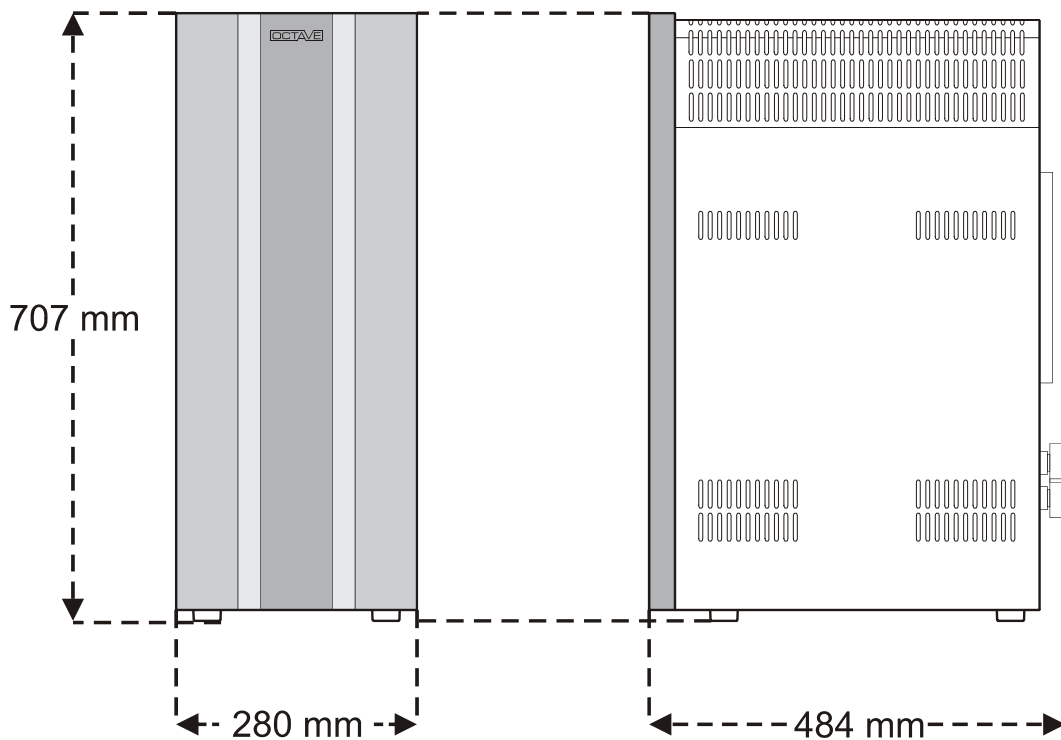

## 9. TECHNICAL DATA, DIAGRAMS

Distortion in % at 10W into 4 ohms between 30 Hz and 20 kHz  
at a variety of bias settings

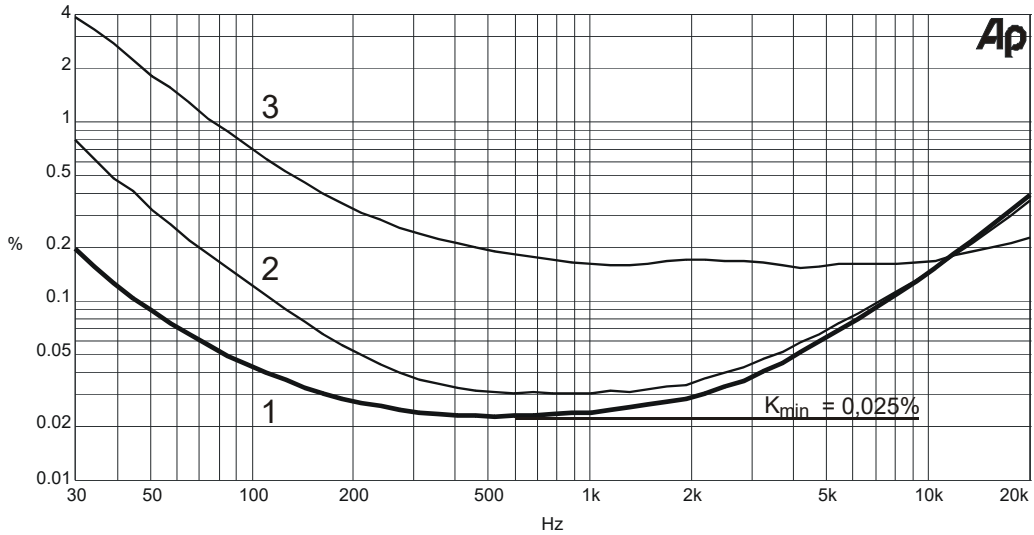

- Curve 1: Bias adjusted correctly; bias high with selected tubes
- Curve 2: Distortion curve with unselected tubes
- Curve 3: Distortion curve bias low

Frequency response

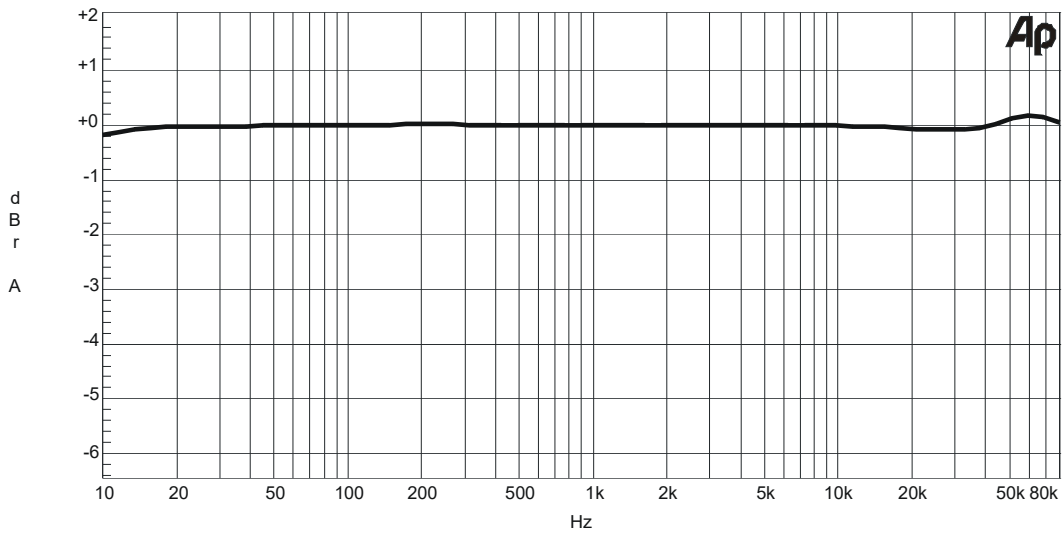

Between 10 Hz and 90 kHz the frequency response tolerance is within 0.3dB

±

## 9. TECHNICAL DATA, DIAGRAMS

Noise spectrum (1 kHz at 10V)

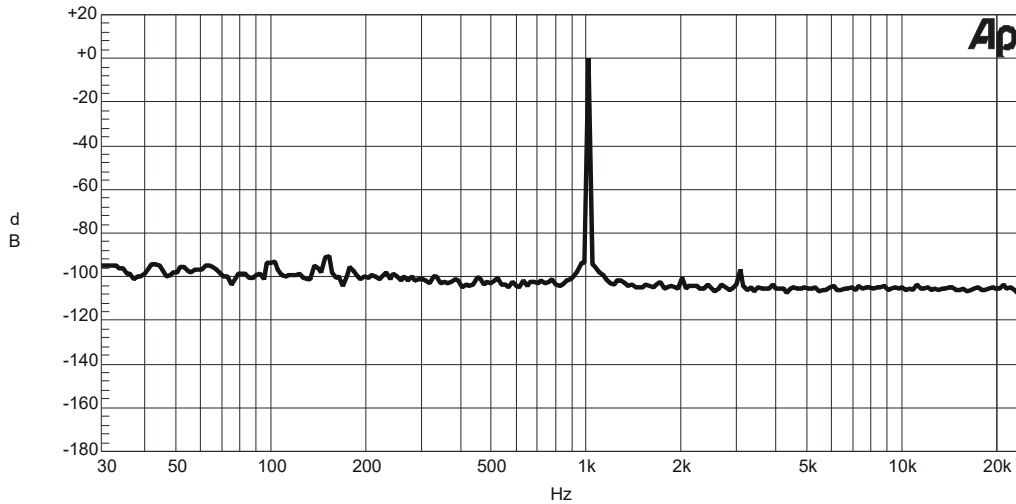

The FFT analysis demonstrates the superb spectral purity of the output signal. No mains-borne noise (normally at 50 and 100Hz) is present

THD between 30Hz and 20 kHz

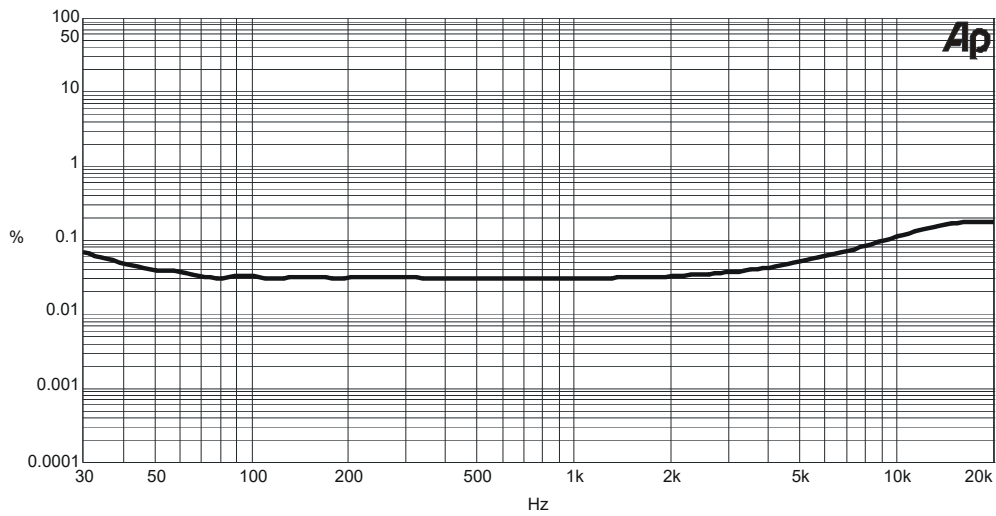

The total harmonic distortion curve is very linear, increasing only slightly at the lowest frequencies. This performance is only possible using a highly specialist output transformer.

## 10. FAQ

---

### 1. Can you operate the amplifier when no loudspeakers are connected?

Yes. All OCTAVE amplifiers are protected against open circuit conditions, i.e. they will not be damaged if operated with the loudspeakers disconnected. However, when connecting your loudspeakers to the amplifier, you should set the volume control on your preamp to 0 to avoid excessive output to the speakers. Protected against open circuit conditions here means without any speakers or speaker cable connected. If you use a "high capacitance" speaker cable, you should make sure that you connect the cable first to the speakers and then to the amplifier.

### 2. Can a short circuit on the speaker outputs damage the amplifier?

At low levels, the power amplifier is absolutely short-circuit proof. At higher levels, the electronic protection is activated. Under normal circumstances, a short circuit condition at the speaker outputs will not damage the amplifier.

### 3. How do you recognize a faulty tube?

There are 3 different symptoms indicating a faulty tube:

1. Broken heater filament: the tube stops glowing
2. Defective cathode layer: the tube glows, but no current can flow. This fault will be shown on the bias display.
3. Short circuit within the tube: This fault will normally trip the electronic protection and cause the red OFF LED to illuminate.

With faults 1 and 2, the amplifier will still operate, although the channel containing the faulty tube will be quieter than normal. At low listening levels, the fault may not be obvious, but distortion will become evident at higher listening levels.

If fault 3 occurs, the protection circuits will normally switch the amplifier off. You may also hear loud background noises just before it switches off, although these will not harm the amplifier. (See chap. 7.2.)

### 4. Is there a loss of sound quality as tubes age?

No. Tubes normally sound the same throughout their service life.

Our soft-start technology contributes greatly to extending the service life of tubes. You can see when an output tube has reached the end of its useful life: it becomes impossible to adjust its bias correct. Driver tubes cannot be checked, but these will generally last for well over 10 years.

### 5. Does the power amplifier have to have all power tubes fitted?

No. The power amplifiers have been designed to operate without a full complement of output tubes for test purposes, or as an interim measure. Power output will, of course, be reduced. Normally, operating the amplifier like this for extended periods will not result in any damage. However, you must not try to run the amplifier at full power.

### 6. What is the significance of loudspeaker impedance and efficiency?

The impedance and efficiency of modern loudspeakers is not an issue for OCTAVE amplifiers. The often-quoted damping factor is not normally a guarantee that an amplifier will exert tight control over the loudspeakers. In practice, speakers of 85dB efficiency and above are suitable for use with tube amplifiers. The high stability of the OCTAVE power amplifier technology even allows the use of speakers whose impedance dips as low as 2 ohms.

### 7. What cables are suitable for tube power amplifiers?

The cable manufacturers are now offering cables that have supposedly been designed specifically for tube amplifiers. Although such cables may be of good quality, there is no need to use special cables with tube amplifiers. Speaker cable can exhibit high values of capacitance and inductance. Tube power amplifiers deal with such loads better than transistor power amplifiers. The only exception would be in the case of tube preamp to power amp interconnect cable longer than 5 meters. In this instance, a low capacitance cable is advisable.



We reserve the right to alter and improve the specifications in pursuit of better. OCTAVE logo is a registered trade mark of Andreas Hofmann. Copyright by Andreas Hofmann. Reproduction in whole or part is prohibited.

OCTAVE AUDIO  
Germany  
[www.octave.de](http://www.octave.de)